

Cameras for vicosys®

Marlin

Colour cameras of Marlin series

Product features

- Digital FireWire cameras of most diverse resolutions
- External trigger
- Progressive Scan
- High Framerate
- Flexible AOI
- Internal image memory
- Opto decoupled I/Os
- Small design
- Compact and robust construction
- C-mount (thread connection)
- Very good price achievement relationship

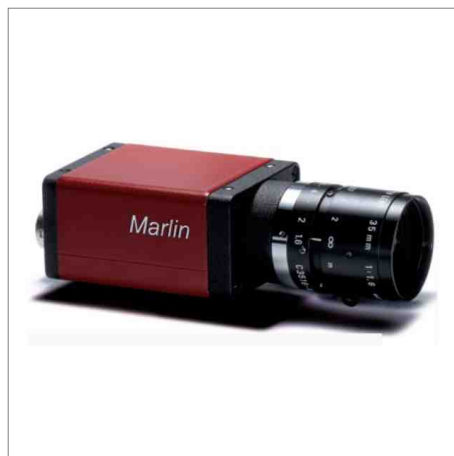

Engineering drawing

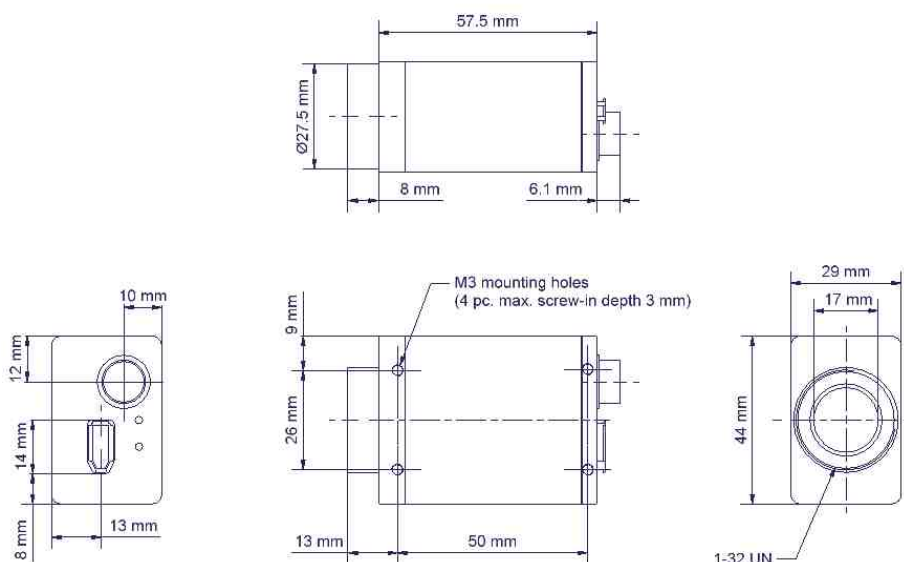

Download
Manual



Download
CAD-File



Definition

The cameras of the Marlin series are available as black/ white and also as color cameras.

The FireWire cameras of the Marlin series differs only in the characteristics of the chip and the maximum framerate.

Variants

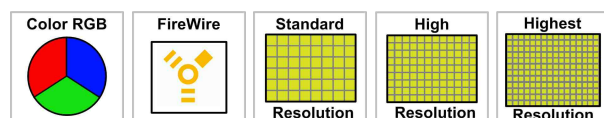

Cameras for vicosys®

Marlin Colour cameras of Marlin series

Technical data

Model	Marlin F-033C 4-22-013	Marlin F-080C 4-22-019	Marlin F-131C 4-22-015	Marlin F-146C 4-22-027	Marlin F-201C 4-22-037
Sensor	1/2" Sony CCD, colour, progressive scan	1/3" Sony CCD, colour, progressive scan	2/3" Sony CMOS, colour	1/2" Sony CCD, colour, progressive scan	1/1.8" Sony CCD, colour, progressive scan
Pixel number	640 x 480	1024 x 768	1280 x 960	1392 x 1040	1600 x 1200
Cell size	9.9 µm x 9.9 µm	4.65 µm x 4.65 µm	6.7 µm x 6.7 µm	4.65 µm x 4.65 µm	4.4 µm x 4.4 µm
Analogue-digital converter	10 bit	10 bit	10 bit	12 Bit	8 Bit
Color modes	Raw8, RGB8, YUV4:2:2, YUV4:1:1	Raw8, RGB8, YUV4:2:2, YUV4:1:1	-	Raw8, RGB8, YUV4:2:2, YUV4:1:1	Raw8, RGB8, YUV4:2:2, YUV4:1:1
Lens mount	C-Mount	C-Mount	C-Mount	C-Mount	C-Mount
Data interface	IEEE 1394a	IEEE 1394a	IEEE 1394a	IEEE 1394a	IEEE 1394a
Transfer rate	100, 200, 400 Mbit/s	100, 200, 400 Mbit/s	100, 200, 400 Mbit/s	100, 200, 400 Mbit/s	100, 200, 400 Mbit/s
Full frame frequency	68 Hz	up to 30 Hz	up to 25 Hz	up to 17.4 Hz	up to 12.5 Hz
Gain Control	Manual: 0 ... 24 dB; Auto gain	Manual: 0 ... 24 dB; Auto gain	Manual: 0 ... 24 dB; Auto gain	Manual: 0 ... 24 dB; Auto gain	Manual: 0 ... 24 dB; Auto gain
Shutter	11 µs...67s, Auto Shutter	11 µs...67s, Auto Shutter	11 µs...67s, Auto Shutter	20 µs...67s, Auto Shutter	20 µs...67s, Auto Shutter
External trigger	Yes	Yes	Yes	Yes	Yes
Voltage supply	8 ... 36 VDC (via IEEE 1394 port)	8 ... 36 VDC (via IEEE 1394 port)	8 ... 36 VDC (via IEEE 1394 port)	8 ... 36 VDC (via IEEE 1394 port)	8 ... 36 VDC (via IEEE 1394 port)
Weight	< 120 g	< 120 g	< 120 g	< 120 g	< 120 g
Dimensions	58 x 44 x 29 mm ³	58 x 44 x 29 mm ³	58 x 44 x 29 mm ³	58 x 44 x 29 mm ³	58 x 44 x 29 mm ³
Operating temperature	+5 ... 45 °C	+5 ... 45 °C	+5 ... 45 °C	+5 ... 45 °C	+5 ... 45 °C

Variants

Variants	Marlin F033C	Marlin F080C	Marlin F131C	Marlin F146C	Marlin F201C
Order number	4-22-013	4-22-019	4-22-015	4-22-027	4-22-037

Cameras for vicosys®

Marlin

Colour cameras of Marlin series

Notes

Scope of delivery

Malin Camera
Camera cable IEEE 1394 4.5m

Technical diagram

Spectral Response Marlin F033C

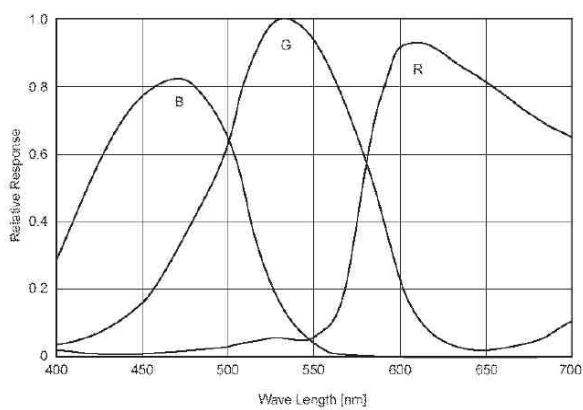

Spectral Response Marlin F080C

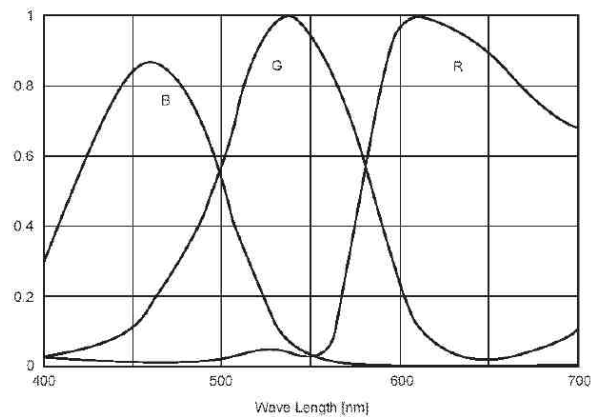

Cameras for vicosys®

Marlin

Colour cameras of Marlin series

Technical diagram

Spectral Response Marlin F131C

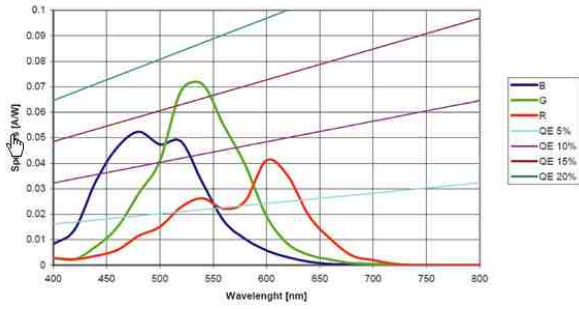

Spectral Response Marlin F146C

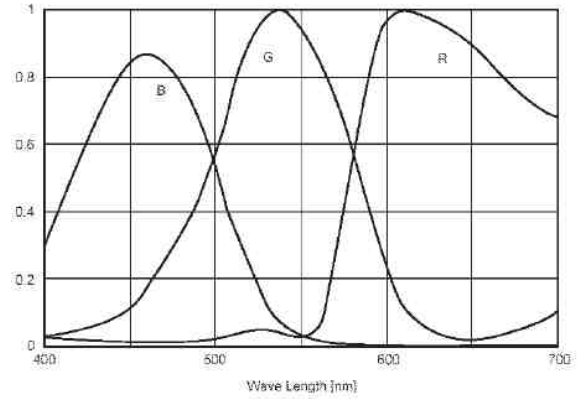

Technical diagram

Spectral Response Marlin F201C

